



UNIVERSITY OF CAMBRIDGE INTERNATIONAL EXAMINATIONS  
International General Certificate of Secondary Education

CANDIDATE  
NAME

CENTRE  
NUMBER

--	--	--	--	--

CANDIDATE  
NUMBER

--	--	--	--

\* 7 5 0 1 4 2 7 8 0 0 \*

**CO-ORDINATED SCIENCES**

**0654/62**

Paper 6 Alternative to Practical

**May/June 2010**

**1 hour**

Candidates answer on the Question paper

No Additional Materials are required.

**READ THESE INSTRUCTIONS FIRST**

Write your Centre number, candidate number and name on all the work you hand in.

Write in dark blue or black pen.

You may use a soft pencil for any diagrams, graphs, tables or rough working.

Do not use staples, paper clips, highlighters, glue or correction fluid.

**DO NOT WRITE IN ANY BARCODES.**

Answer **all** questions.

At the end of the examination, fasten all your work securely together.

The number of marks is given in brackets [ ] at the end of each question or part question.

For Examiner's Use	
1	
2	
3	
4	
5	
6	
<b>Total</b>	

This document consists of **18** printed pages and **2** blank pages.



1 This question is about variation in leaves.

- (a) A student was provided with the 20 leaves shown in Fig. 1.2. Measure the length  $l$  of each leaf in millimetres as shown in Fig. 1.1a. If the lamina does not meet the petiole evenly on either side of the leaf use the longer measurement. See Fig. 1.1b.

Enter your measurements in Table 1.1.

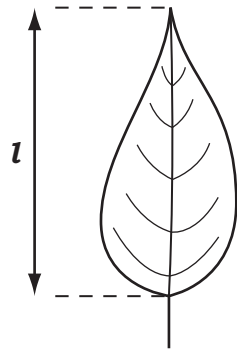

Fig. 1.1a

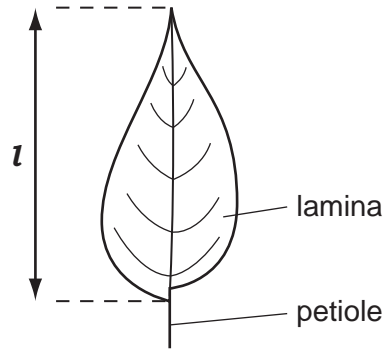
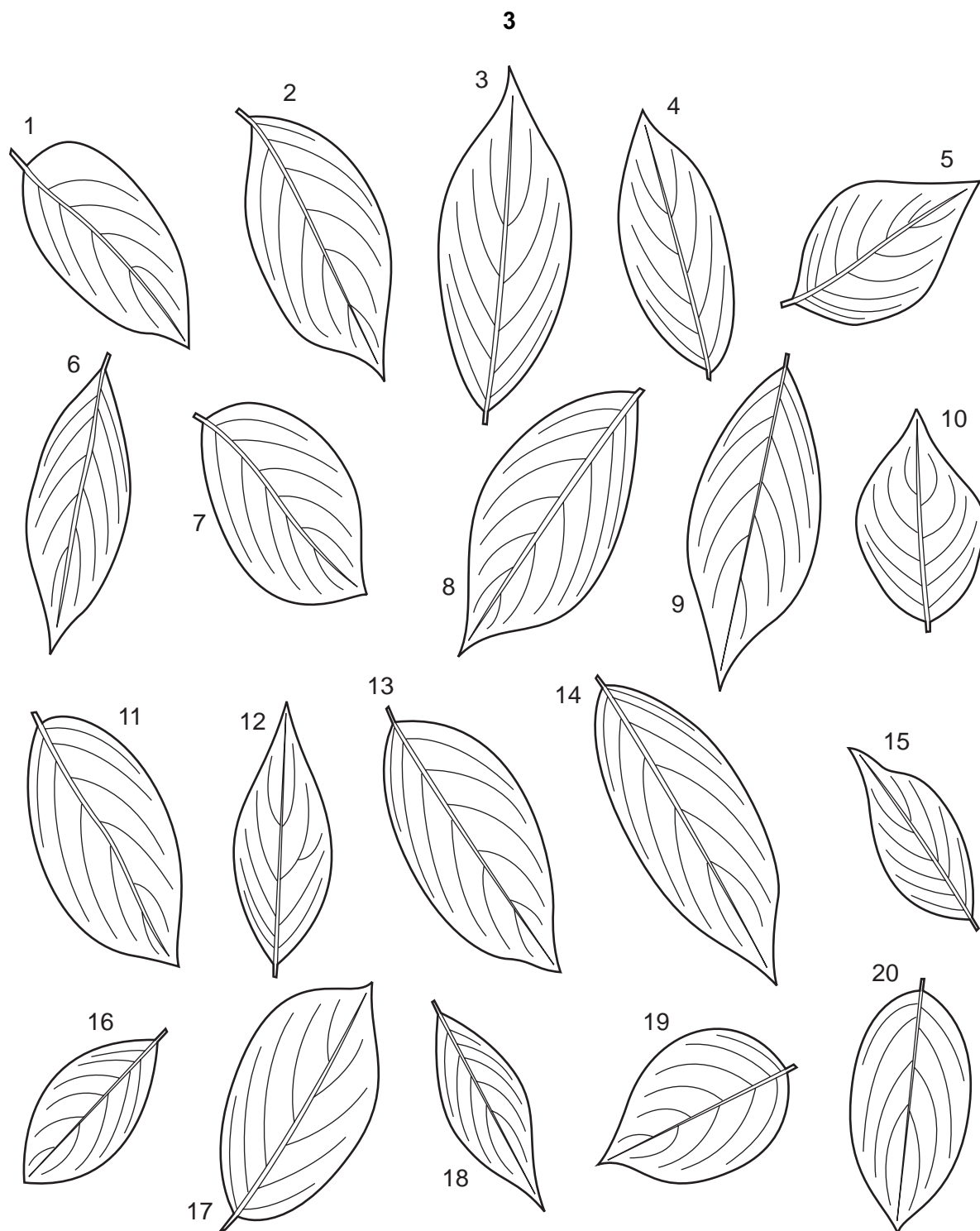

Fig. 1.1b

Table 1.1

length of leaf $l$ / mm			
1		11	
2		12	
3		13	
4		14	
5		15	
6		16	
7		17	
8		18	
9		19	
10		20	

[2]



**Fig. 1.2**

**(b)** Calculate the average (mean) length of the 20 leaves. Show your working.

average = ..... mm

[2]

(c) (i) Enter the number of leaves in each range in Table 1.2 below.

For  
Examiner's  
Use

Table 1.2

range / mm	number of leaves in range
30 - 34	
35 - 39	
40 - 44	
45 - 49	
50 - 54	
55 - 59	

[2]

(ii) Using the information you have entered in Table 1.2 draw a bar chart on the grid provided. Use the **number of leaves in range** as the vertical axis and the **range / mm** as the horizontal axis. Choose suitable scales for your data.

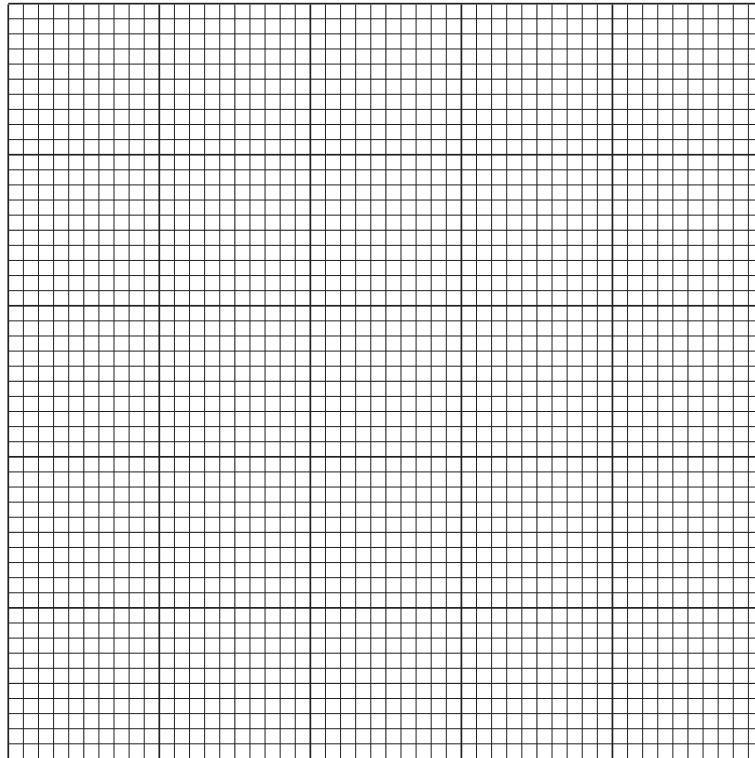

[3]

(d) The leaves were all of the same species yet they showed variation in length. Suggest a reason for this.

.....  
 ..... [1]

- 2 Some science students are making ammonia gas,  $\text{NH}_3$ . They are mixing solid calcium hydroxide,  $\text{Ca}(\text{OH})_2$  and ammonium chloride,  $\text{NH}_4\text{Cl}$ . Then they are heating the mixture in the apparatus shown in Fig. 2.1.

For  
Examiner's  
Use

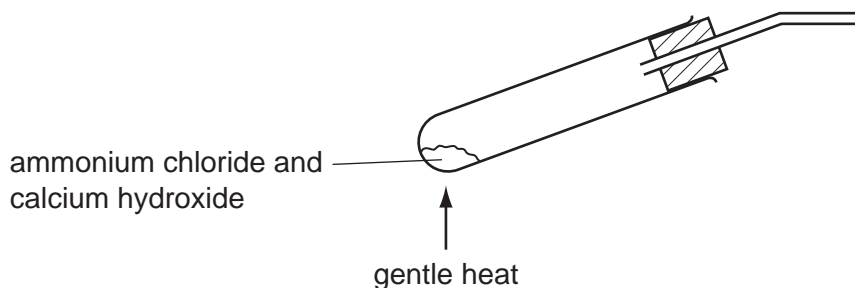

Fig. 2.1

- (a) (i) State the colour of ammonia gas.

..... [1]

- (ii) Water, ammonia and a solid substance are formed when calcium hydroxide reacts with ammonium chloride.

**Name** the solid substance that is formed. Do not write its formula.

..... [1]

- (b) The students have to decide how to collect the gas that will come out of the delivery tube. The teacher gives them the information shown in Table 2.1.

Table 2.1

name of gas	air	ammonia
density of gas in $\text{g / dm}^3$	1.2	0.7

Three methods of collecting a gas are shown in Fig. 2.2.

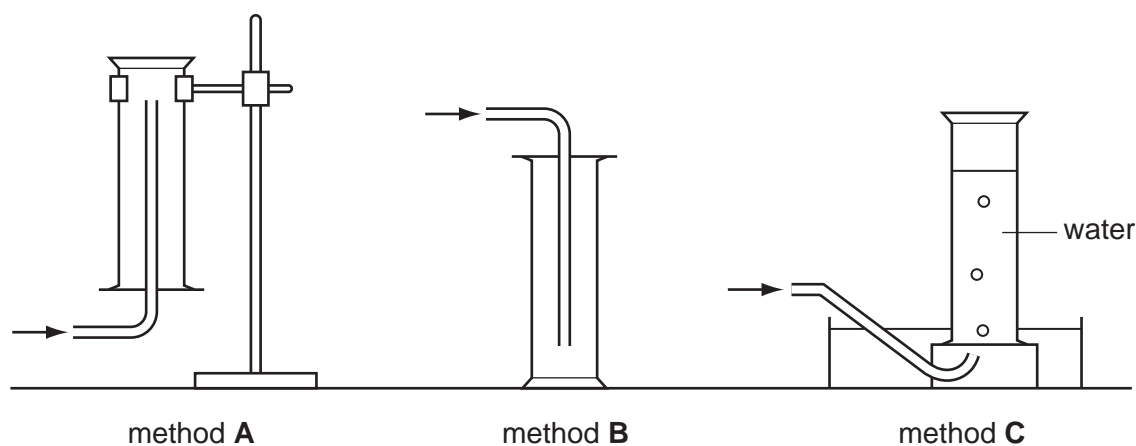

Fig. 2.2

- (i) Study methods **A**, **B** and **C** in Fig. 2.2. Choose the best method of collecting ammonia gas. Use the information in Table 2.1 and your knowledge of the properties of ammonia to help you to choose.

The best way to collect ammonia gas is method ..... [1]

- (ii) Choose **one** of the other two methods and complete the sentence below.

Method ..... is **not** a good way to collect ammonia gas because .....

.....

..... [1]

- (c) The students have collected some gas-jars of ammonia. They are testing the gas using the tests shown in Table 2.2.

Complete Table 2.2.

**Table 2.2**

test	result
(i) A few cm <sup>3</sup> of aqueous ..... [1] sulfate is added to the gas.	A white precipitate is formed. After shaking, the precipitate re-dissolves forming a colourless solution.
(ii) A few cm <sup>3</sup> of aqueous copper(II) sulfate is added to the gas.	A precipitate is formed which has a ..... [2] colour. After shaking, the precipitate re-dissolves forming a ..... solution.
(iii) A few drops of litmus is added.	The litmus turns ..... [1]

- (d) The teacher carries out an experiment with the gas-jar of ammonia. He soaks a filter paper in concentrated hydrochloric acid. Then he holds the filter paper at the mouth of the gas-jar of ammonia. This is shown in Fig 2.3.

For  
Examiner's  
Use

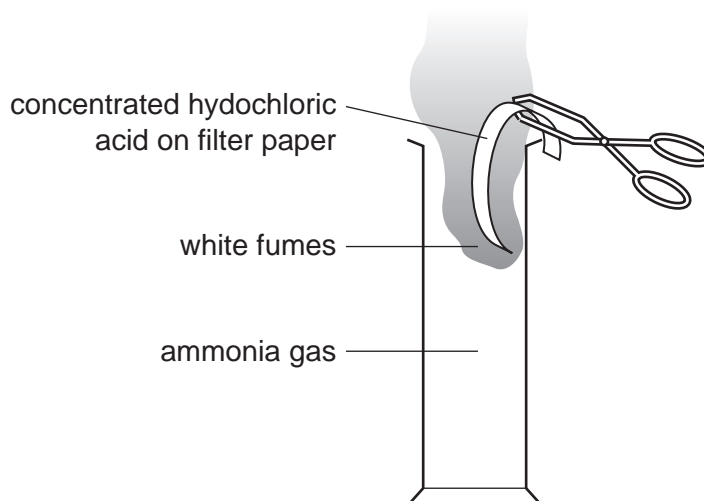

**Fig. 2.3**

The students see a cloud of white fumes.

Explain how the white fumes are formed.

.....

.....

..... [2]

- 3 A science student is trying to find out how much a liquid expands when it is turned into a gas. He is using water as the liquid. The apparatus is shown in Fig 3.1.

For  
Examiner's  
Use

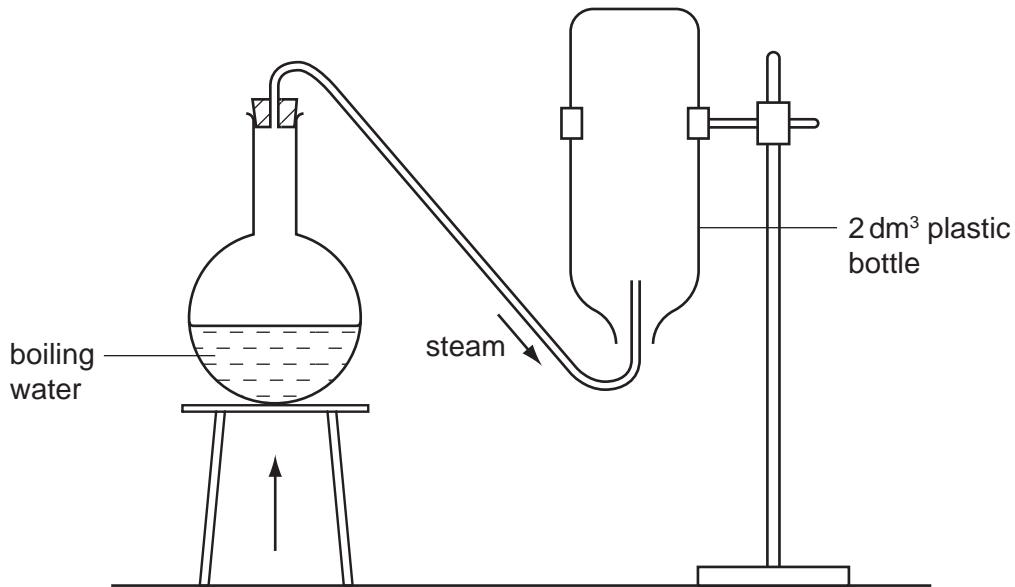

Fig. 3.1

- He weighs a clean, dry plastic 2 dm<sup>3</sup> bottle with its lid on and records the mass,  $m_1$ .
- He removes the lid and places the bottle in position as in Fig. 3.1.
- He boils the water and passes steam into the bottle for three or four minutes until the bottle is at 100 °C and no drops of water remain in it. The bottle is now full of steam.
- He quickly removes the bottle from its stand, places it upright and loosely replaces the lid.
- When the bottle has cooled to room temperature he weighs it again and records the mass,  $m_2$ .

The balance windows for the masses,  $m_1$  and  $m_2$  are shown in Fig. 3.2.



Fig. 3.2

- (a) (i) Read and record the masses of the bottle,  $m_1$  and  $m_2$ , before and after passing steam into it.

mass  $m_1$  = ..... g

mass  $m_2$  = ..... g [2]



(ii) Find the increase in mass of the bottle.

For  
Examiner's  
Use

increase in mass of the bottle= ..... g [1]

(b) Changing water into steam is a reversible process.

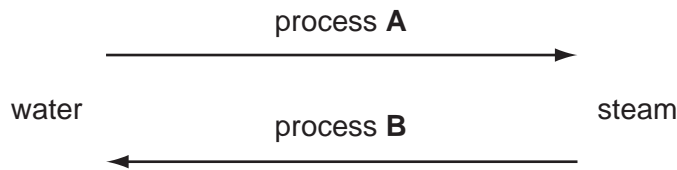

(i) Name process A ..... [1]

(ii) Name process B ..... [1]

The mass of water produced when the 2 dm<sup>3</sup> of steam cooled down is given in your answer to (a)(ii).

1 g of water has a volume of 1 cm<sup>3</sup>.

(c) (i) What volume of water was produced when the 2 dm<sup>3</sup> of steam cooled down?

volume of water = ..... cm<sup>3</sup> [1]

(ii) Calculate the volume produced, in cubic centimetres, when 1 cubic centimetre of water is heated and becomes steam.

volume of steam from 1 cm<sup>3</sup> of water = ..... cm<sup>3</sup> [2]

(d) In a steam engine, water is heated to give steam. Use the result of this experiment to explain why a powerful force is produced by a steam engine.

.....  
.....  
..... [2]

- 4 This question compares the content of inhaled air with exhaled air. The experiment was done using gas-jars of inhaled and exhaled air.

For  
Examiner's  
Use

- (a) Gas-jars that had been standing open in the laboratory were used for samples of inhaled air.

In the space below draw a labelled diagram to show how you would collect a sample of exhaled air in a gas-jar.

[2]

- (b) To compare the oxygen content of the air a student lit a candle and placed it in the gas-jar. The length of time that the flame burned was noted and the results were entered in Table 4.1. The experiment was repeated three times with each type of air.

Table 4.1

source of air sample	time of burning / s			
	test 1	test 2	test 3	average
inhaled air		7.0	6.5	
exhaled air	5.0		4.5	

- (i) Read the stop watches in Fig. 4.1 and enter the results in Table 4.1.

[2]

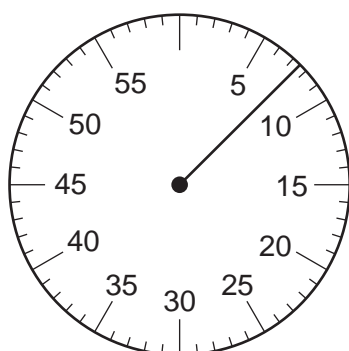

inhaled air, **test 1**  
time / s

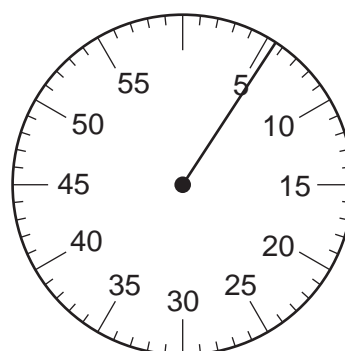

exhaled air, **test 2**  
time / s

Fig. 4.1

- (ii) Calculate the average time of burning of the candle in each sample of air and enter your results in Table 4.1.

[2]

- (c) To compare the carbon dioxide content of inhaled and exhaled air the student continuously shook a fixed volume of limewater in the gas-jar of air.

- (i) No change was noted with the inhaled air after shaking the sample with limewater for one minute. However the limewater changed appearance within seconds when exhaled air was tested.

What was observed in the gas-jar of exhaled air?

..... [1]

- (ii) The carbon dioxide content of air is increased by the lungs. What process in the body produces carbon dioxide?

..... [1]

- (iii) The student then shook fresh limewater with more samples of exhaled air. One sample was collected **before exercise** and the other **after exercise**. The student forgot which sample was which. The times taken for the limewater to change were 3.2 s and 8.4 s.

Enter the times in the correct place in Table 4.2.

Table 4.2

exhaled air sample	time taken for change / s
before exercise	
after exercise	

[1]

- (iv) Explain why exercise changes the carbon dioxide content of exhaled air.

.....  
 .....  
 ..... [1]

- 5 A student is investigating the rate of reaction between magnesium and dilute hydrochloric acid. She does several experiments using different concentrations of the acid with the same lengths of magnesium ribbon. Fig. 5.1 shows the apparatus she is using.

For  
Examiner's  
Use

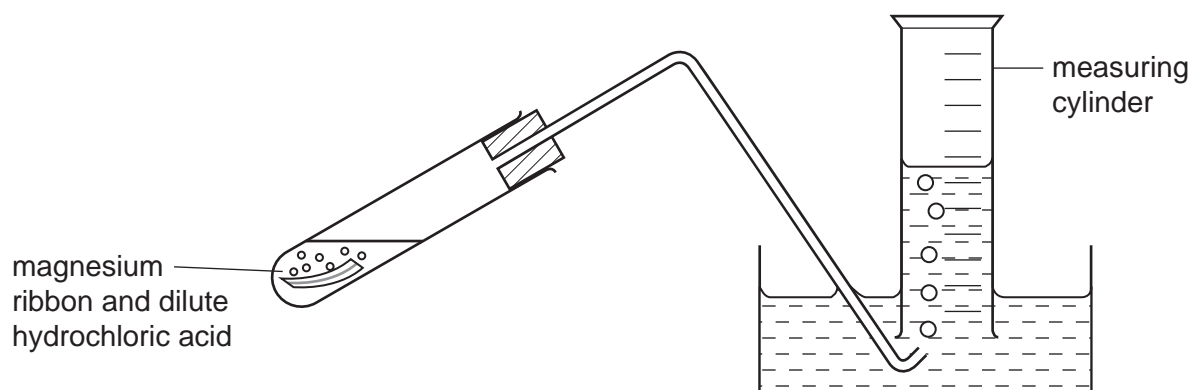

Fig. 5.1

- She measures out the volume of dilute hydrochloric acid for experiment 1, shown in Table 5.1, and places it in the test-tube.
- She adds water to make the total volume of liquid equal to  $20\text{ cm}^3$ .
- She cuts a 6 cm length of magnesium ribbon, puts it in the test-tube and quickly replaces the stopper and the delivery tube.
- After 40 seconds she measures the volume of hydrogen in the measuring cylinder and records it in Table 5.1.
- She carries out experiments 2, 3, 4 and 5 in the same way.

Table 5.1

experiment no.	volume of acid/cm <sup>3</sup>	volume of water/cm <sup>3</sup>	concentration of the acid in the test-tube/mol/dm <sup>3</sup>	volume of hydrogen after 40 s/cm <sup>3</sup>
1	20	0	2.0	80
2	16	4	1.6	
3	12	8		
4	8	12		20
5	4	16		

For  
Examiner's  
Use

(a) Fig. 5.2 shows the measuring cylinder readings for experiments 2, 3 and 5.

Read the volumes of hydrogen and record the readings in Table 5.1.

[3]

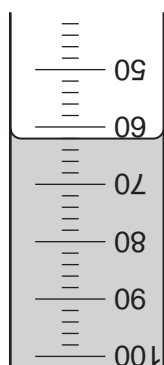

volume of hydrogen  
after 40 s  
experiment 2

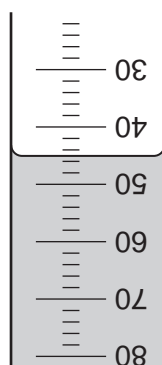

volume of hydrogen  
after 40 s  
experiment 3

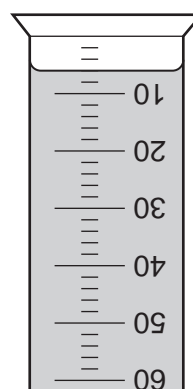

volume of hydrogen  
after 40 s  
experiment 5

Fig. 5.2

(b) Calculate the concentration of the acid in the test-tube used in experiments 3, 4, and 5.

Complete Table 5.1.

[1]

- (c) Plot a graph of **volume of hydrogen / cm<sup>3</sup>** (vertical axis) against **concentration of hydrochloric acid in mol/dm<sup>3</sup>** on the graph grid.

Draw the best straight line and extend it to pass through the origin.

*For  
Examiner's  
Use*

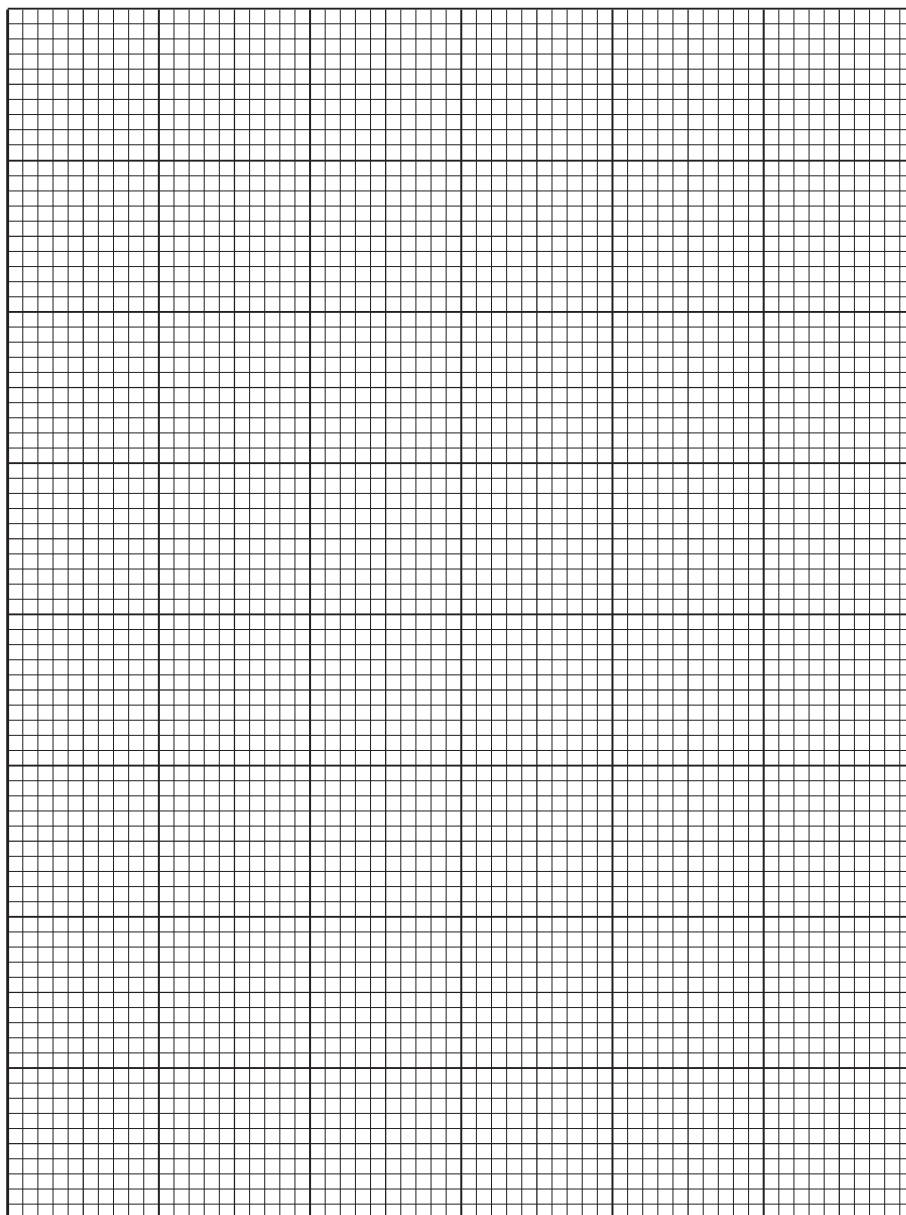

[3]

- (d) (i) To make the experiment fair, it is important for the student to use the same length of magnesium ribbon in all of these experiments.

Suggest **two** reasons for this.

reason 1 .....

reason 2 ..... [2]

- (ii) What does the shape of the graph show about the relationship between the volume of hydrogen given off in 40 seconds and the concentration of the acid used?

.....

..... [1]

- 6 The science teacher has asked the students to find the heat capacity of a metal food can. They heat water and then pour it into the weighed metal food can. Then they find the new temperature of the water.

For  
Examiner's  
Use

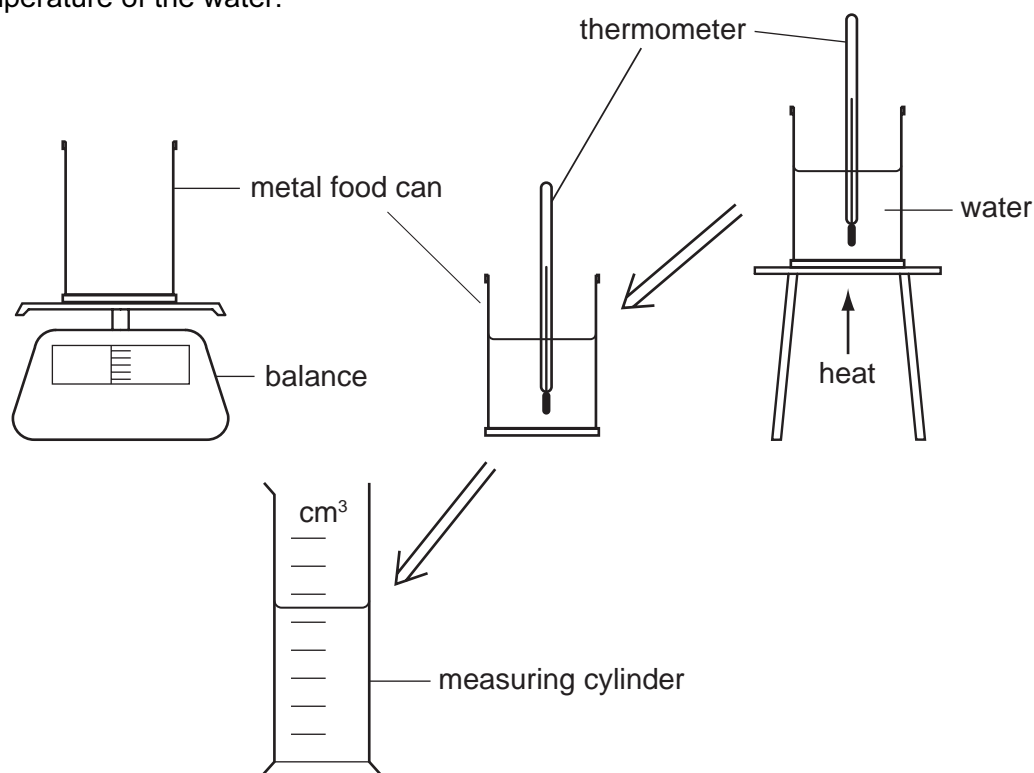

Fig. 6.1

- The food can is weighed to find its mass,  $m$ .
- The room temperature,  $t_1$ , is recorded in Table 6.1.
- Some water is heated and its temperature,  $t_2$ , is found.
- The water is poured into the can, it is stirred and the new temperature of the water and the metal food can  $t_3$ , is found.
- A measuring cylinder is used to find the volume of water,  $v$  cm<sup>3</sup>.

- (a) Study the diagram, Fig. 6.2, and read the balance window, the measuring cylinder and the thermometers. Record these values in Table 6.1.

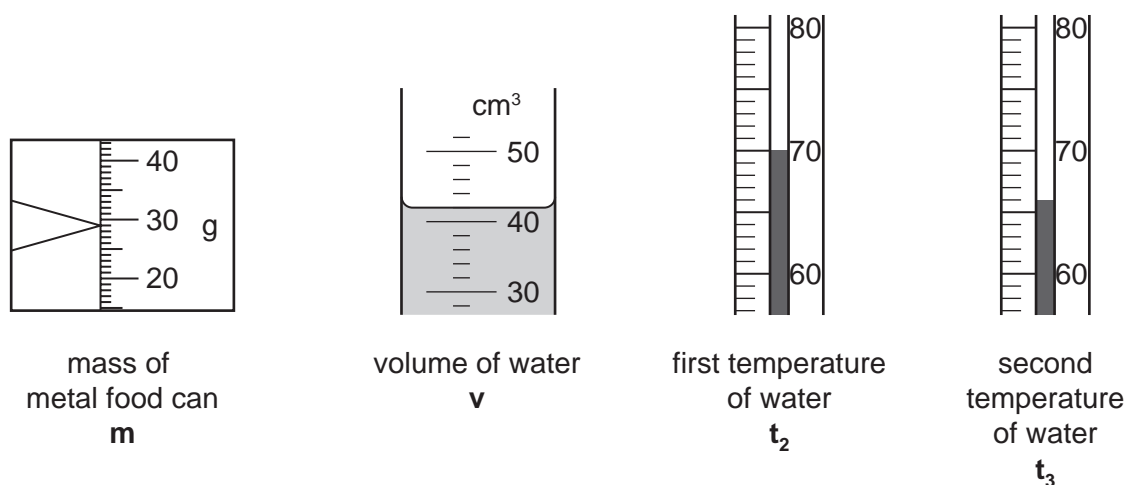

Fig. 6.2



Table 6.1

mass of metal food can	<b>m</b> = ..... g
room temperature	<b>t</b> <sub>1</sub> = 25 °C
first temperature of water	<b>t</b> <sub>2</sub> = ..... °C
second temperature of water	<b>t</b> <sub>3</sub> = ..... °C
volume of water	<b>v</b> = ..... cm <sup>3</sup>

For  
Examiner's  
Use

[4]

- (b) (i) The room temperature was 25 °C. Find **p**, the increase in the temperature of the metal food can, (**t**<sub>3</sub> - 25) °C.

$$\mathbf{p} = \text{.....} \text{ } ^\circ\text{C} \quad [1]$$

- (ii) Find **q**, the decrease in the temperature of the water.

$$\mathbf{q} = \text{.....} \text{ } ^\circ\text{C} \quad [1]$$

- (iii) Find the specific heat of the metal of the food can using the formula below.

$$\text{specific heat} = \frac{\mathbf{q} \times \text{mass of water} \times 4.2}{\mathbf{p} \times \mathbf{m}} \text{ Jg}^{-1}\text{ } ^\circ\text{C}^{-1}$$

$$\text{specific heat of the metal} = \text{.....} \text{ Jg}^{-1}\text{ } ^\circ\text{C}^{-1} \quad [2]$$

(c) The teacher says that the specific heat of the metal of the food can may be found using an electric heater. He sets up the apparatus shown in Fig. 6.3.

For  
Examiner's  
Use

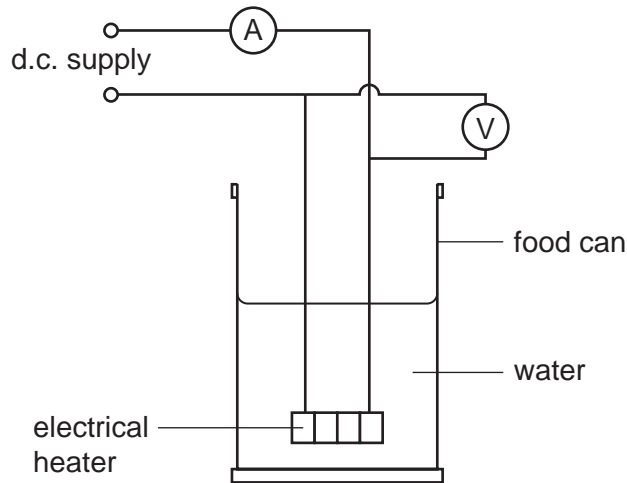

Fig. 6.3

**E**, the amount of energy supplied by the heater is equal to the energy absorbed by the water and the food can. To calculate **E**, the total energy supplied by the heater, three **different variables** must be measured and recorded.

Complete the list of these three values and their correct units. One of them has been done for you.

1. The e.m.f. in volts.
2. .... in .....
3. .... in ..... [2]



**BLANK PAGE**

---

Permission to reproduce items where third-party owned material protected by copyright is included has been sought and cleared where possible. Every reasonable effort has been made by the publisher (UCLES) to trace copyright holders, but if any items requiring clearance have unwittingly been included, the publisher will be pleased to make amends at the earliest possible opportunity.

University of Cambridge International Examinations is part of the Cambridge Assessment Group. Cambridge Assessment is the brand name of University of Cambridge Local Examinations Syndicate (UCLES), which is itself a department of the University of Cambridge.